

YD2035

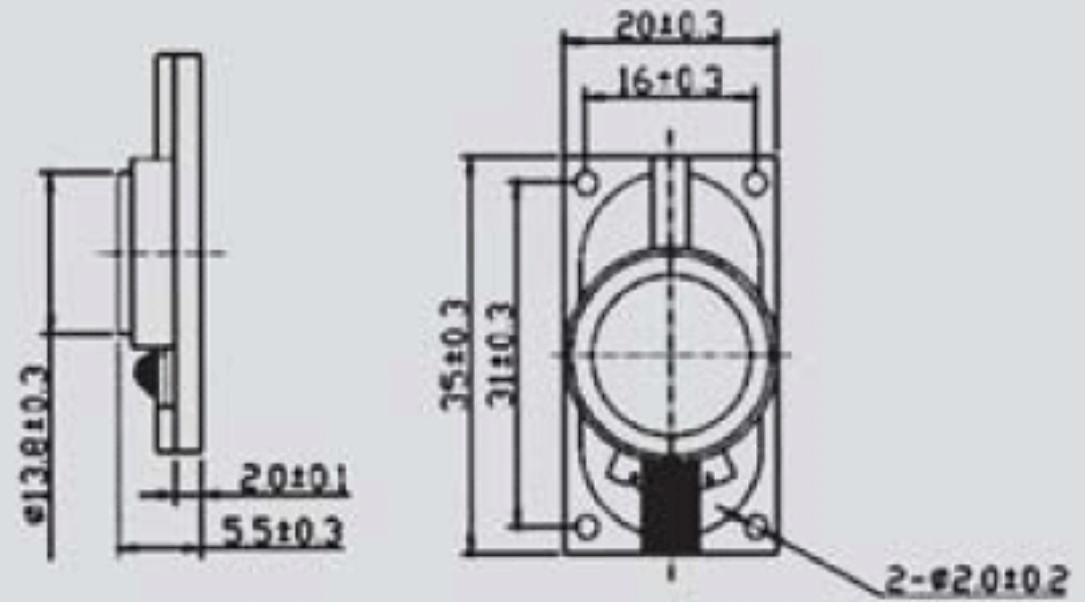

DIMENSIONS

UNIT:mm

Tolerance: ± 0.5 mm

SPECIFICATIONS

Rated Impedance	Ω	$8 \pm 15\%$
Rated(Max)Power	W	1.0/2.0
Resonant Frequency	Hz	$750 \pm 20\%$
Rated Freq.Range	Hz	$f_0 \sim 2000$
Sound Pressure Level 0.1W/0.5m(AVG at 0.8,1.0,1.2,1.5)kHz	dB	84 ± 3
Weight	g	4.3
Operating Temperature	$^{\circ}\text{C}$	$-10 \sim +40$

